

DATA SHEET

AWB7127H: 2.11 to 2.17 GHz Small-Cell Power Amplifier Module

Applications

- LTE, WCDMA and HSDPA air interfaces
- Picocell, femtocell, home nodes
- Customer premises equipment
- Data cards and terminals

Features

- InGaP HBT technology
- -50 dBc ACPR @ ± 5 MHz, +24.5 dBm
- 33 dB gain
- High efficiency
- Low transistor junction temperature
- Internally matched for a 50 Ω system
- Low-profile miniature surface-mount package; halogen free and RoHS compliant
- Multi-carrier capability
- Surface-mount package (14-pin, 7 x 7 x 1.3 mm) (MSL4, 260 °C per JEDEC J-STD-020)



Skyworks Green™ products are compliant with all applicable legislation and are halogen-free. For additional information, refer to *Skyworks Definition of Green™*, document number SQ04-0074.



Description

The AWB7127H is a highly linear, fully matched, power amplifier module designed for picocell, femtocell, and customer premises equipment (CPE) applications. Its high-power efficiency and low adjacent channel power levels meet the extremely demanding needs of small cell infrastructure architectures. Designed for LTE, WCDMA and HSDPA air interfaces operating in the 2.11 to 2.17 GHz band, the AWB7127H delivers up to +24.5 dBm of WCDMA (64 DPCH) power with an ACPR of -50 dBc. It operates from a convenient +4.2 V supply and provides 33 dB of gain.

The device is manufactured using an advanced InGaP HBT MMIC technology offering state-of-the-art reliability, temperature stability, and ruggedness. The self-contained 7 mm x 7 mm x 1.3 mm surface-mount package incorporates RF matching networks optimized for output power, efficiency, and linearity in a 50 Ω system.

A functional block diagram is shown in Figure 1. The pin configuration and package are shown in Figure 2. Signal pin assignments and functional pin descriptions are provided in Table 1.

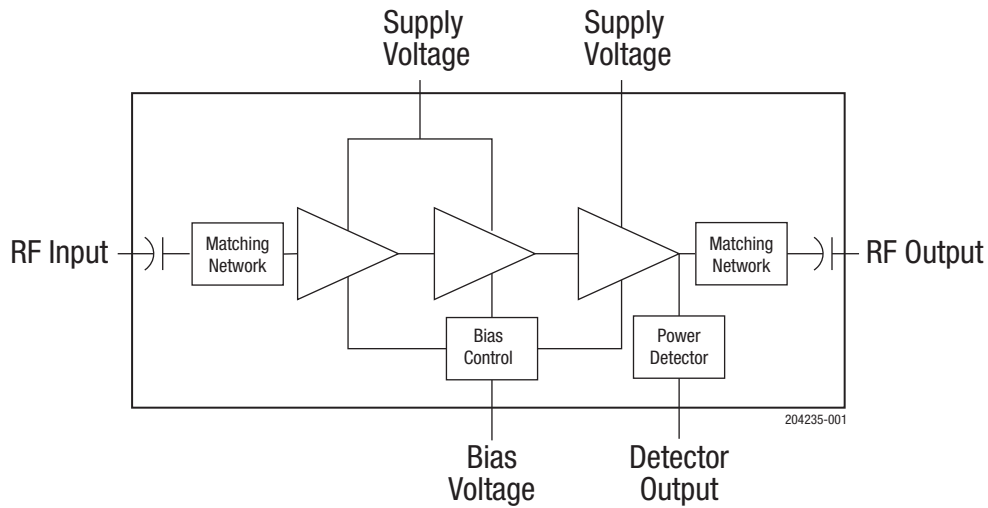

Figure 1. AWB7127H Block Diagram

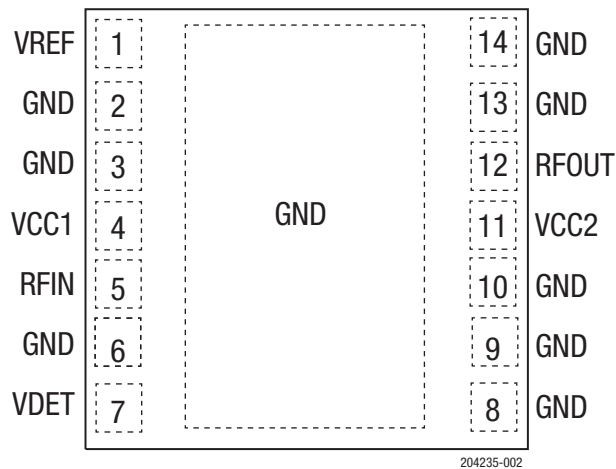

Figure 2. AWB7127H Pinout (Top View)

Table 1. AWB7127H Signal Pin Descriptions

Pin	Name	Description	Pin	Name	Description
1	VREF	Reference voltage	8	GND	Ground
2	GND	Ground	9	GND	Ground
3	GND	Ground	10	GND	Ground
4	VCC1	Supply voltage	11	VCC2	Supply voltage
5	RFIN	RF input	12	RFOUT	RF output
6	GND	Ground	13	GND	Ground
7	VDET	Detector voltage	14	GND	Ground

Electrical and Mechanical Specifications

The absolute maximum ratings of the AWB7127H are provided in Table 2. Recommended operating conditions are specified in Table 3, and DC characteristics are shown in Table 4. Electrical specifications are provided in Table 5.

The state of the AWB7127H is determined by the logic provided in Table 6.

Table 2. AWB7127H Absolute Maximum Ratings¹

Parameter	Symbol	Minimum	Maximum	Units
Supply voltage	V _{CC}	0	+5	V
Reference voltage	V _{REF}	0	+3.5	V
RF output power	P _{OUT}		+28	dBm (modulated)
RF input power	P _{IN}		+10	dBm, CW
Juncture temperature	T _J		+150	°C
Storage temperature	T _{STG}	-40	+150	°C
Electrostatic discharge:	ESD			
Human Body Model, Class 1C			2000	V
Charged Device Model, Class 4			1000	V

¹ Exposure to maximum rating conditions for extended periods may reduce device reliability. There is no damage to device with only one parameter set at the limit and all other parameters set at or below their nominal value. Exceeding any of the limits listed here may result in permanent damage to the device.

ESD HANDLING: *Although this device is designed to be as robust as possible, electrostatic discharge (ESD) can damage this device. This device must be protected at all times from ESD when handling or transporting. Static charges may easily produce potentials of several kilovolts on the human body or equipment, which can discharge without detection. Industry-standard ESD handling precautions should be used at all times.*

Table 3. AWB7127H Recommended Operating Conditions

Parameter	Symbol	Min	Typ	Max	Units
Operating frequency	f	2110		2170	MHz
Supply voltage	V _{CC}	+3.2	+4.2	+4.5	V
Reference voltage:					
PA on	V _{REF}	+2.80	+2.85	+2.90	V
PA off		0		+0.5	V
RF output power ¹	P _{OUT}		+24.5		dBm
Case temperature ²	T _c	-40		+85	°C

¹ Typ RF output power is used during production test.

² Case temperature references the board temperature at the ground paddle on the backside of the package.

Table 4. AWB7127H Electrical Specifications¹
(T_C = +25 °C, V_{CC} = +4.2 V, V_{REF} = +2.85 V, 50 Ω system)

Parameter	Symbol	Test Condition	Min	Typ	Max	Units
Gain ²	G		29	33	36	dB
ACPR: ^{1,2,3} @ 5 MHz @ 10 MHz				-50 -62	-47 -56	dBc dBc
Power-added efficiency ^{1,2,3}			14.5	17		%
Thermal resistance	R _{JC}	Junction to case		22		°C/W
Supply current ^{1,2,3}		Total through VCC pins		400	463	mA
Quiescent current	I _{cq}			120	140	mA
Reference current		Through VREF pin		7	10	mA
Leakage current		V _{CC} = +5 V, V _{REF} = 0 V		1.5	5	μA
Harmonics: ^{1,2} 2fo 3fo, 4fo				-52 -50	-46 -50	dBc dBc
Input return loss			10	14		dB
Spurious output level (all spurious outputs)		P _{OUT} ≤ +24.5 dBm, in-band load VSWR < 5:1, Out-of-band load VSWR < 10:1, applies over all voltage and temperature operating ranges			-60	dBc
Load mismatch stress with no permanent degradation or failure		V _{CC} = +4.2 V, P _{IN} = 0 dBm Applies over full operating temperature range	8:1			VSWR

¹ ACPR and efficiency measured at 2140 MHz.

² P_{OUT} = +24.5 dBm.

³ TM1 WCDMA 64 DPCH

Evaluation Board Description

The AWB7127H Evaluation Board is used to test the performance of the AWB7127H linear power amplifier. A schematic of a typical application circuit is shown in Figure 3.

Shutdown Mode

The power amplifier can be placed in a shutdown mode by applying logic low levels (see Operating Ranges table) to the V_{REF} voltage.

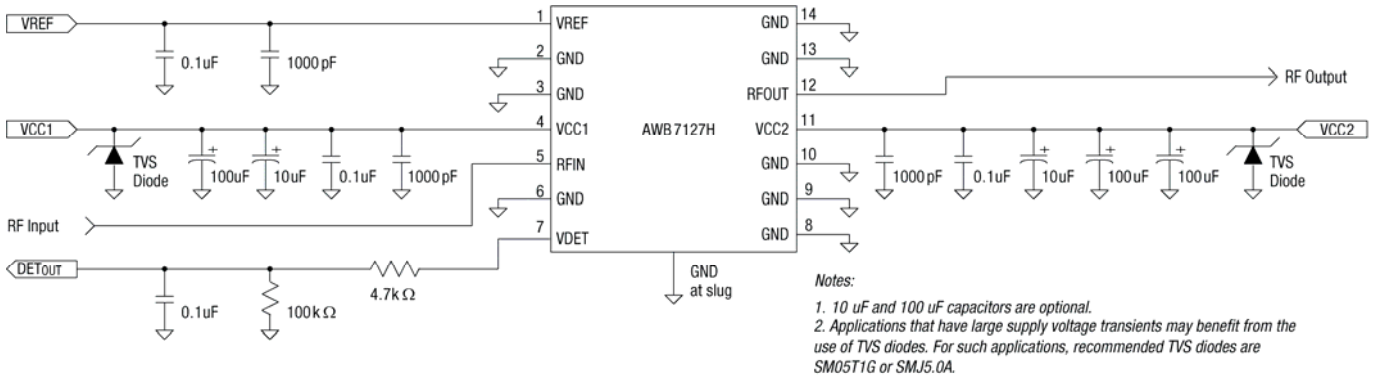

204235-003

Figure 3. AWB7127H Application Circuit Schematic

Package Dimensions

The PCB layout footprint for the AWB7127H is shown in Figure 4. Typical part markings are noted in Figure 5. Package dimensions are shown in Figure 6, and tape and reel dimensions are provided in Figure 7.

Package and Handling Information

Since the device package is sensitive to moisture absorption, it is baked and vacuum packed before shipping. Instructions on the shipping container label regarding exposure to moisture after the container seal is broken must be followed. Otherwise, problems related to moisture absorption may occur when the part is subjected to high temperature during solder assembly.

The AWB7127H is rated to Moisture Sensitivity Level 4 (MSL4) at 260 °C. It can be used for lead or lead-free soldering. For additional information, refer to the Skyworks Application Note, *Solder Reflow Information*, document number 200164.

Care must be taken when attaching this product, whether it is done manually or in a production solder reflow environment. Production quantities of this product are shipped in a standard tape and reel format.

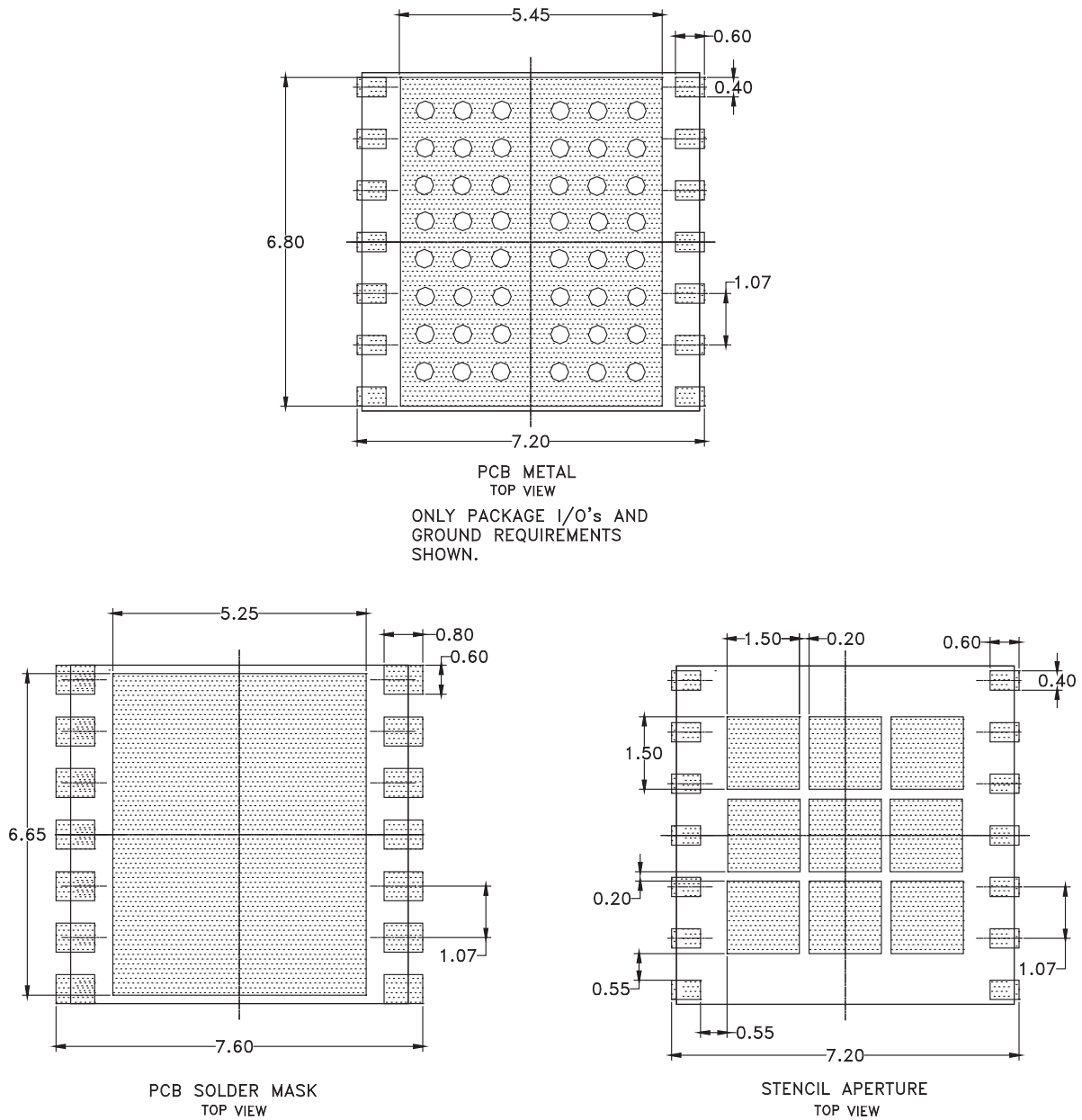

Notes:

1. Unless specified, dimensions are symmetrical about center lines shown.
2. Dimensions are in millimeters.
3. Vias shown in PCB Metal View are for reference only. Number and size of thermal vias required are dependent on heat dissipation requirements and the PCB process capability.

204235-004

Figure 4. PCB Layout Footprint

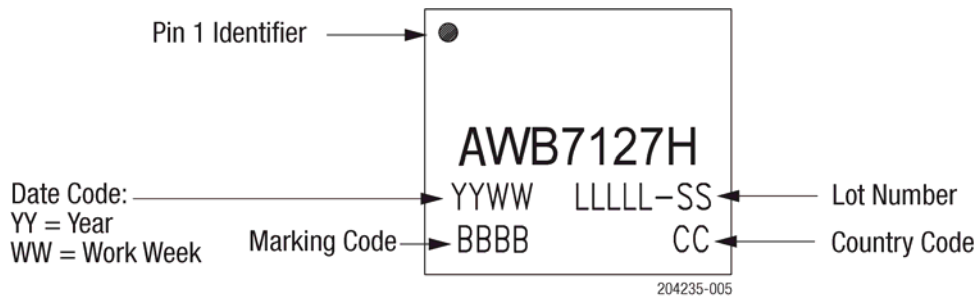
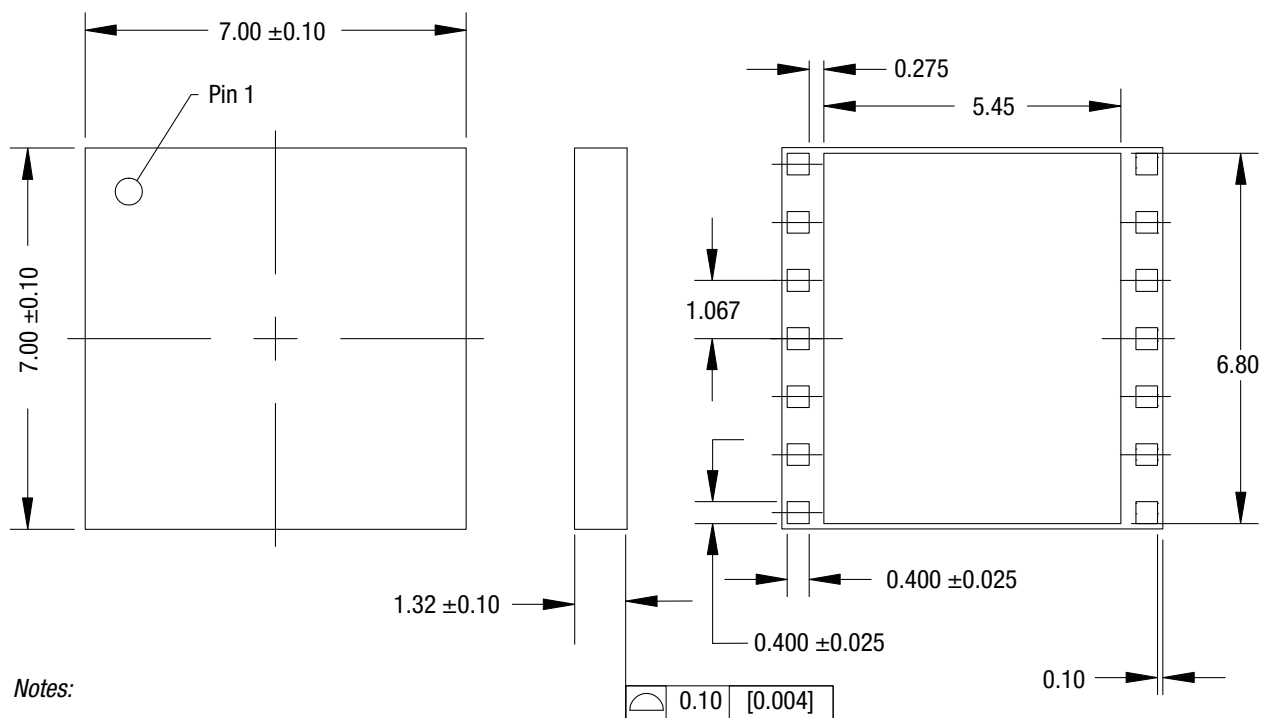

Figure 5. Typical Part Markings (Top View)



Notes:

1. All dimensions are in millimeters.
2. Unless specified otherwise, tolerance = ± 0.076 [0.003].
3. Pads (including center) are shown as uniform size for reference only.
Actual pad size and location will vary within the minimum and maximum dimensions according to the specific laminate design.

204235-006

Figure 6. AWB7127H Package Dimensions

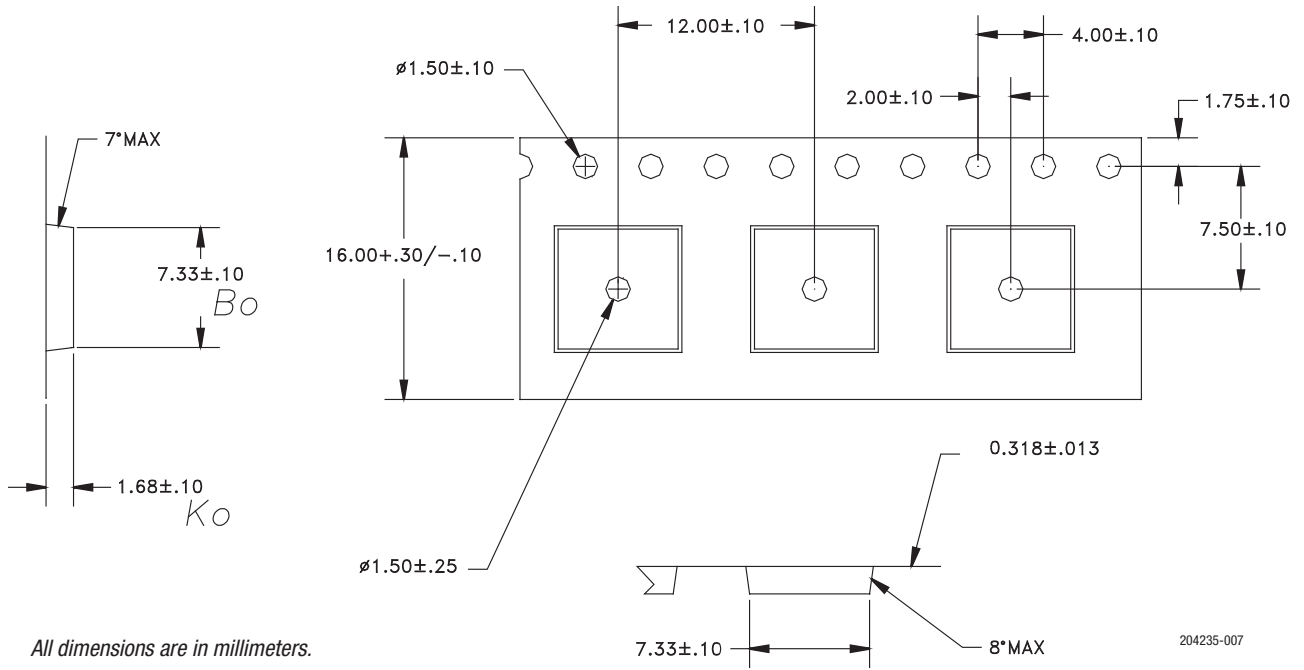

Figure 7. AWB7127H Tape and Reel Dimensions

Ordering Information

Part Number	Product Description	Packaging
AWB7127HM41P8	2.11 to 2.17 GHz Small-Cell PA Module	Tape and reel, 2500 pieces per reel

Copyright © 2017-2018 Skyworks Solutions, Inc. All Rights Reserved.

Information in this document is provided in connection with Skyworks Solutions, Inc. ("Skyworks") products or services. These materials, including the information contained herein, are provided by Skyworks as a service to its customers and may be used for informational purposes only by the customer. Skyworks assumes no responsibility for errors or omissions in these materials or the information contained herein. Skyworks may change its documentation, products, services, specifications or product descriptions at any time, without notice. Skyworks makes no commitment to update the materials or information and shall have no responsibility whatsoever for conflicts, incompatibilities, or other difficulties arising from any future changes.

No license, whether express, implied, by estoppel or otherwise, is granted to any intellectual property rights by this document. Skyworks assumes no liability for any materials, products or information provided hereunder, including the sale, distribution, reproduction or use of Skyworks products, information or materials, except as may be provided in Skyworks Terms and Conditions of Sale.

THE MATERIALS, PRODUCTS AND INFORMATION ARE PROVIDED "AS IS" WITHOUT WARRANTY OF ANY KIND, WHETHER EXPRESS, IMPLIED, STATUTORY, OR OTHERWISE, INCLUDING FITNESS FOR A PARTICULAR PURPOSE OR USE, MERCHANTABILITY, PERFORMANCE, QUALITY OR NON-INFRINGEMENT OF ANY INTELLECTUAL PROPERTY RIGHT; ALL SUCH WARRANTIES ARE HEREBY EXPRESSLY DISCLAIMED. SKYWORKS DOES NOT WARRANT THE ACCURACY OR COMPLETENESS OF THE INFORMATION, TEXT, GRAPHICS OR OTHER ITEMS CONTAINED WITHIN THESE MATERIALS. SKYWORKS SHALL NOT BE LIABLE FOR ANY DAMAGES, INCLUDING BUT NOT LIMITED TO ANY SPECIAL, INDIRECT, INCIDENTAL, STATUTORY, OR CONSEQUENTIAL DAMAGES, INCLUDING WITHOUT LIMITATION, LOST REVENUES OR LOST PROFITS THAT MAY RESULT FROM THE USE OF THE MATERIALS OR INFORMATION, WHETHER OR NOT THE RECIPIENT OF MATERIALS HAS BEEN ADVISED OF THE POSSIBILITY OF SUCH DAMAGE.

Skyworks products are not intended for use in medical, lifesaving or life-sustaining applications, or other equipment in which the failure of the Skyworks products could lead to personal injury, death, physical or environmental damage. Skyworks customers using or selling Skyworks products for use in such applications do so at their own risk and agree to fully indemnify Skyworks for any damages resulting from such improper use or sale.

Customers are responsible for their products and applications using Skyworks products, which may deviate from published specifications as a result of design defects, errors, or operation of products outside of published parameters or design specifications. Customers should include design and operating safeguards to minimize these and other risks. Skyworks assumes no liability for applications assistance, customer product design, or damage to any equipment resulting from the use of Skyworks products outside of stated published specifications or parameters.

Skyworks and the Skyworks symbol are trademarks or registered trademarks of Skyworks Solutions, Inc. or its subsidiaries in the United States and other countries. Third-party brands and names are for identification purposes only, and are the property of their respective owners. Additional information, including relevant terms and conditions, posted at www.skyworksinc.com, are incorporated by reference.